

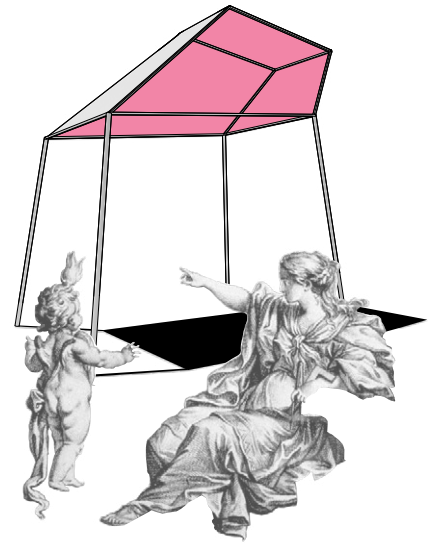

MARC-ANTOINE LAUGIER
1753



PRIMITIVE HUT



NON_PAVILION

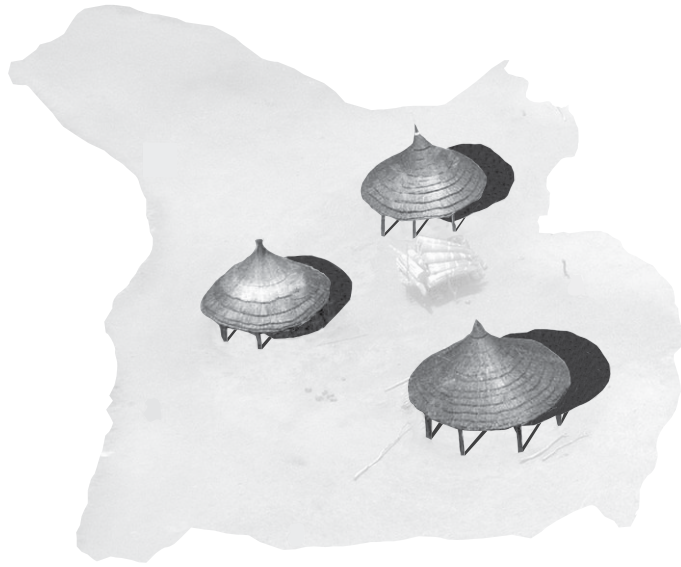

SOUTH SUDAN, AFRICA.
1993

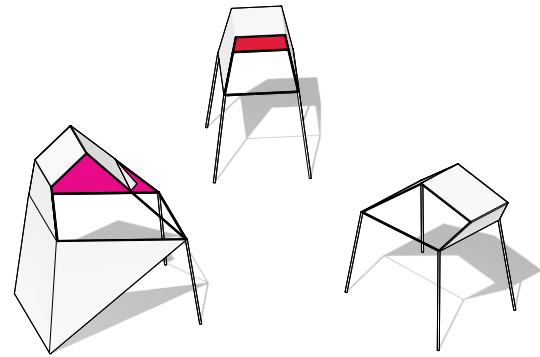

NON_PAVILION AS VILLAGE

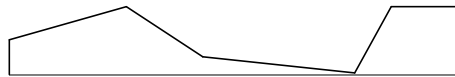

CULLEN SCULPTURE GARDEN, ISAMU NOGUCHI
1986

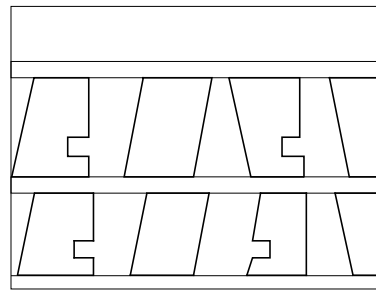

GLASELL MUSEUM, STEVEN HOLL
2018

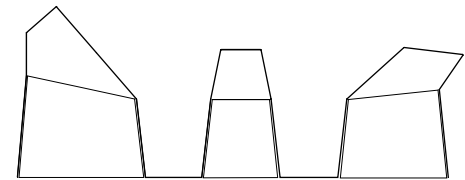

NON_PAVILION
2019

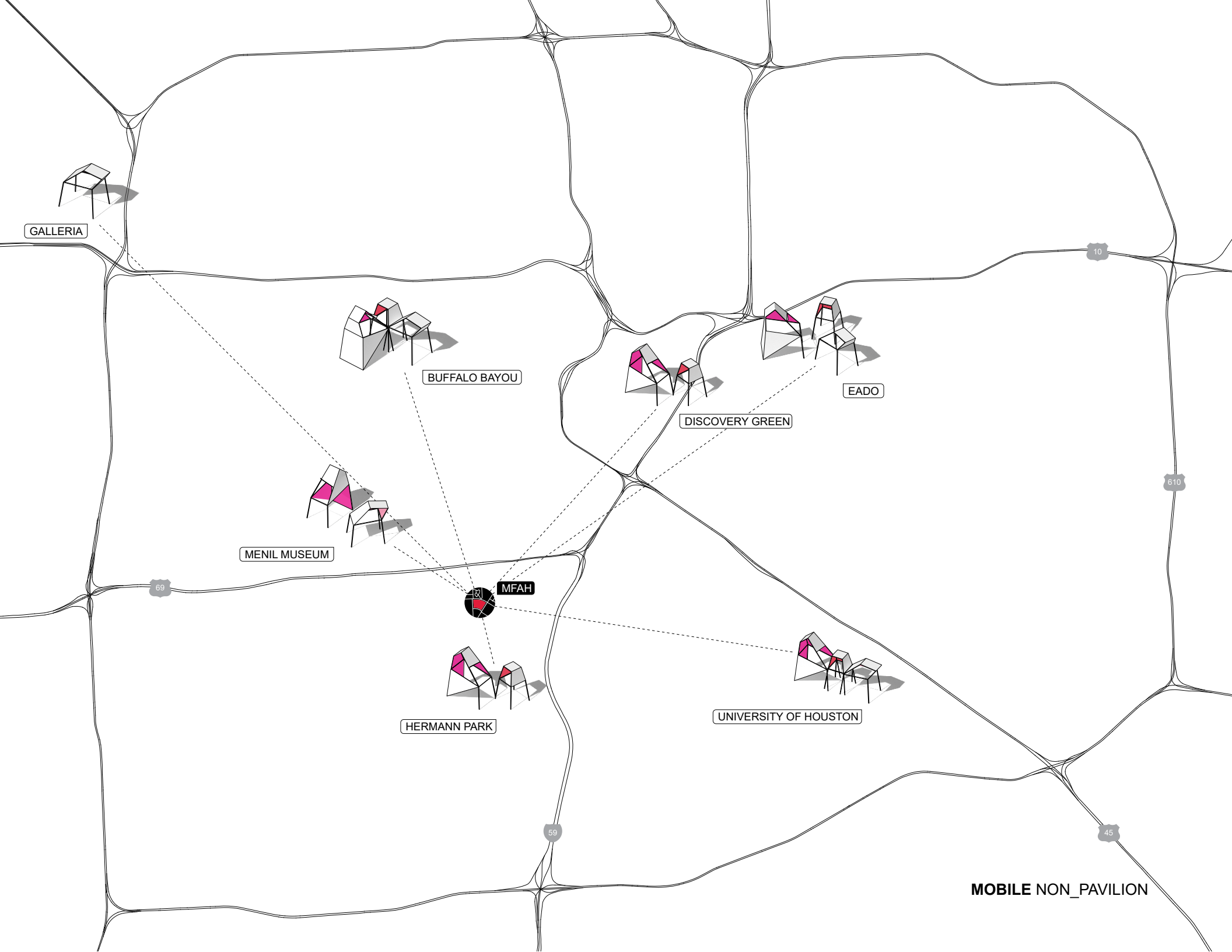

GALLERIA

BUFFALO BAYOU

MENIL MUSEUM

MFAH

HERMANN PARK

DISCOVERY GREEN

EADO

UNIVERSITY OF HOUSTON

MOBILE NON_PAVILION

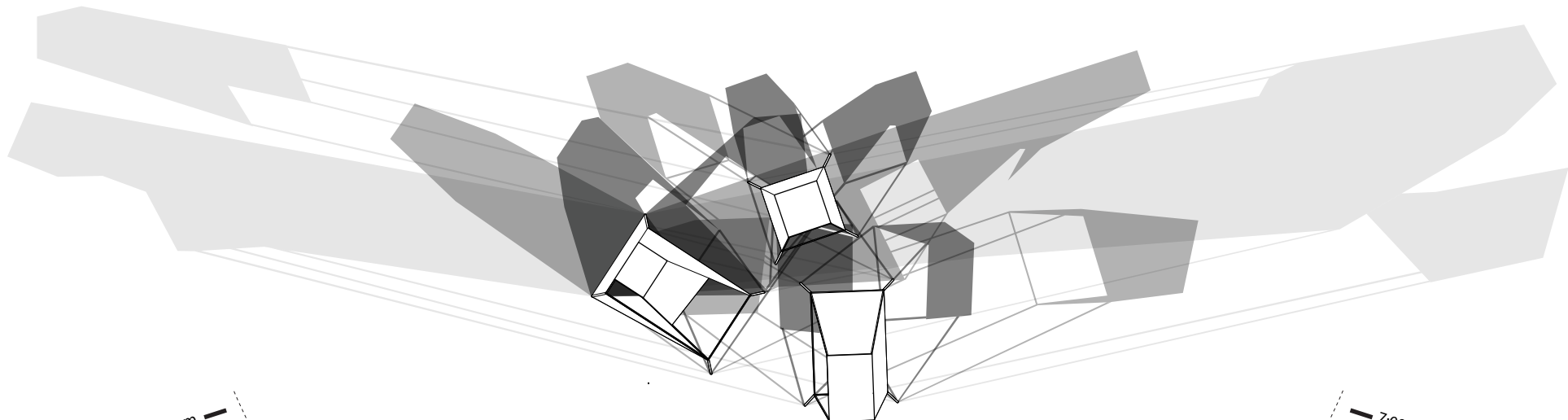

5:00 pm

7:00 am

3:00 pm

3:00 am

12:00 pm

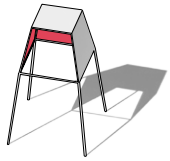

A

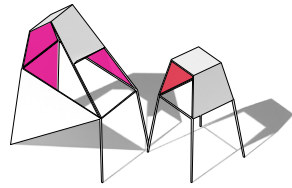

AB

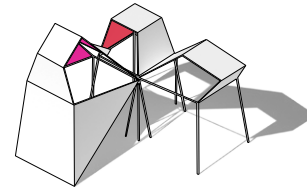

ABC

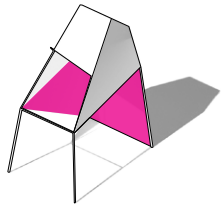
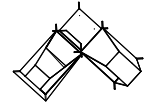

B

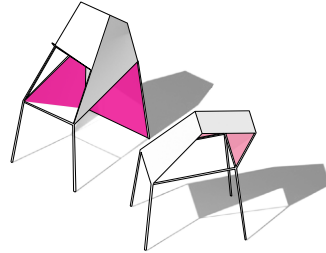

BC

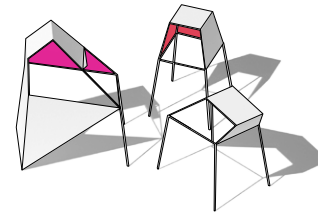

CLUSTER

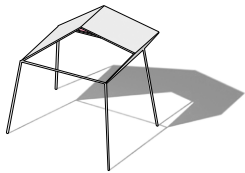
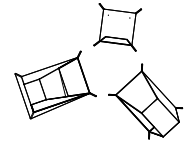

C

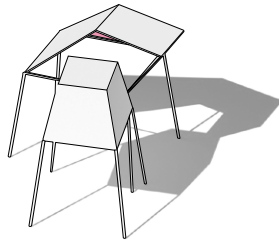

CA

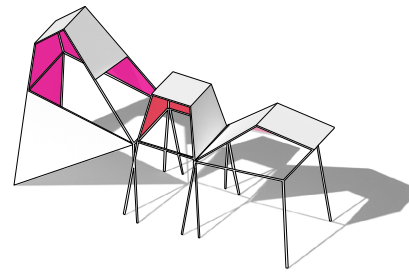

LINE

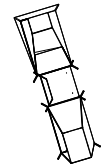

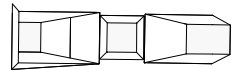
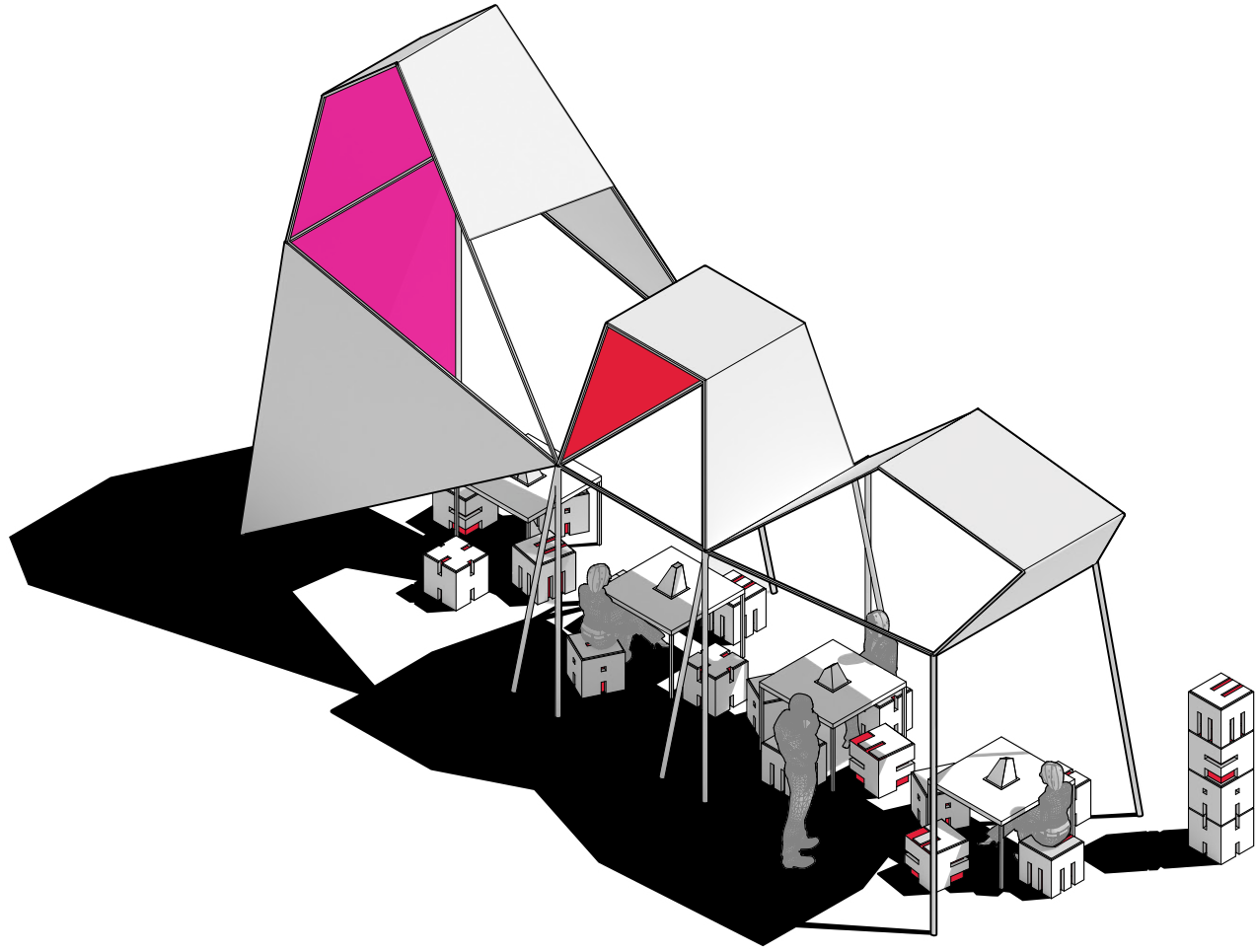

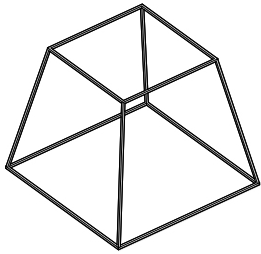

A

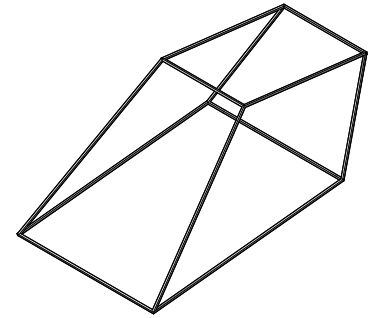
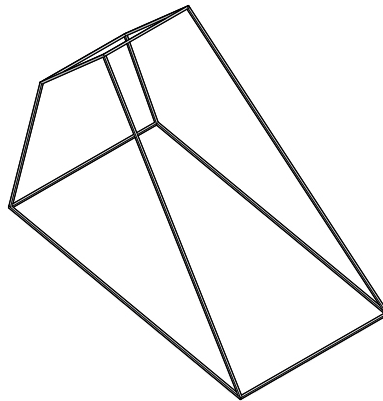

C

3 CANOPIES

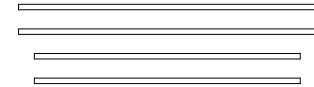
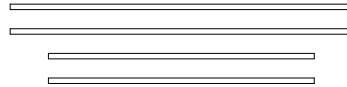
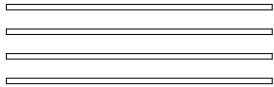

12 LEGS

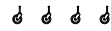

12 WHEELS



12 EARTHSCREWS

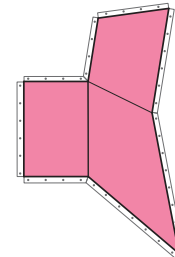
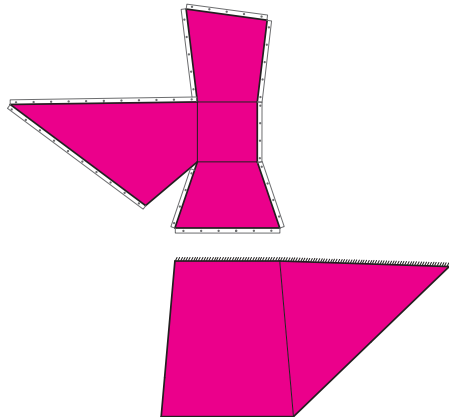
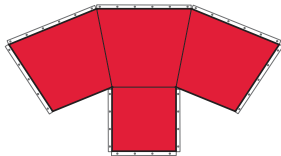

4 WALLS

KIT OF PARTS

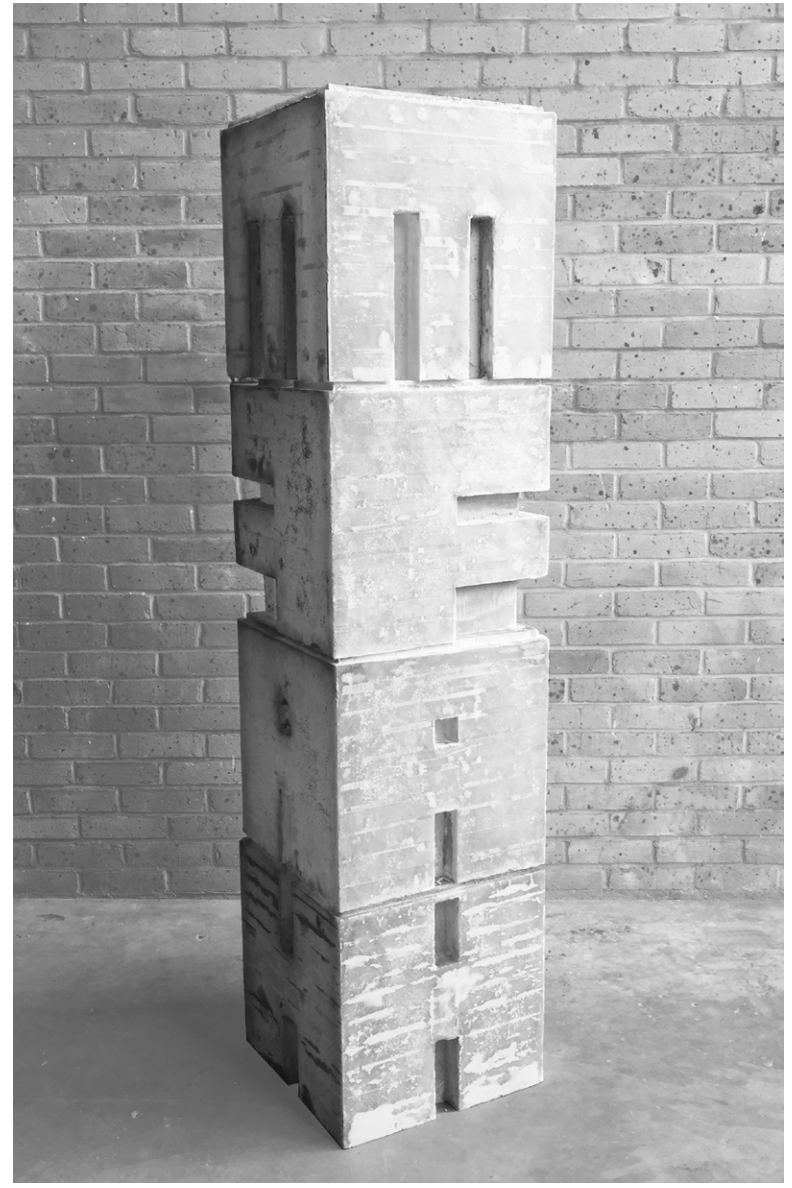
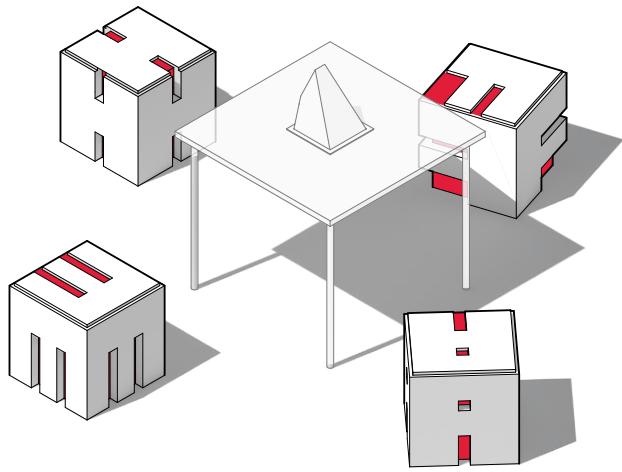

STOOLS

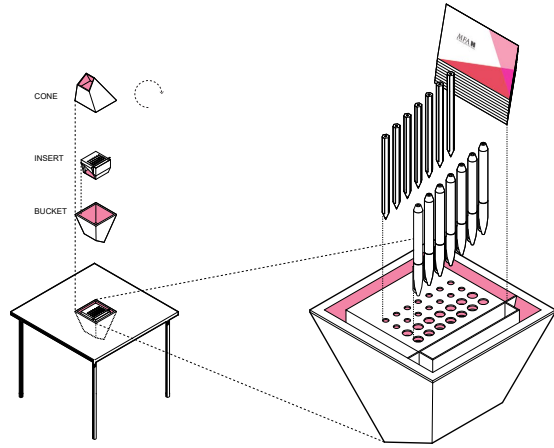
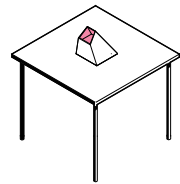
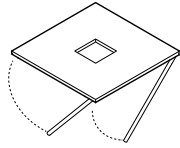
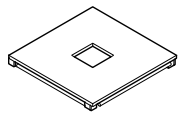

COMMUNITY TABLE

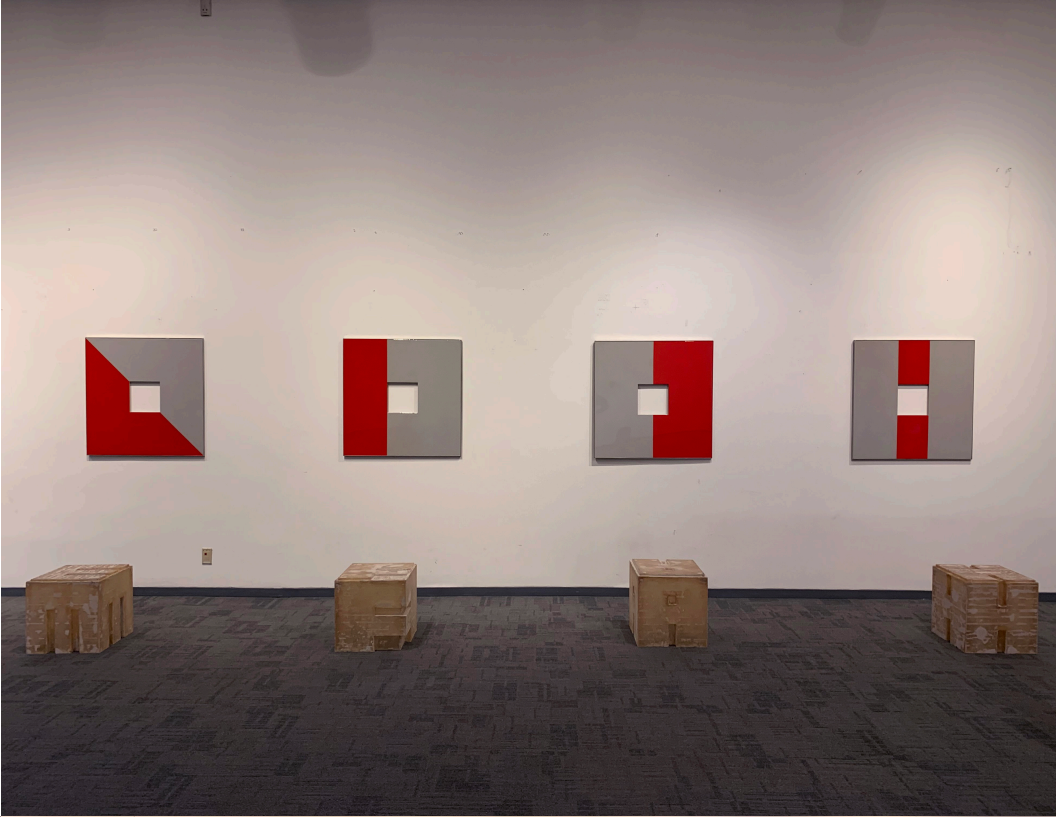

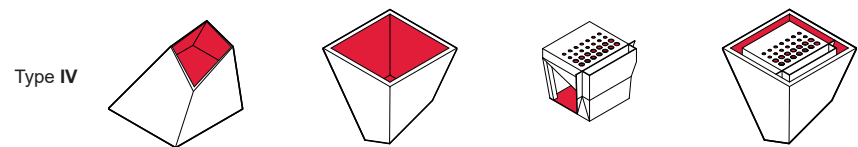
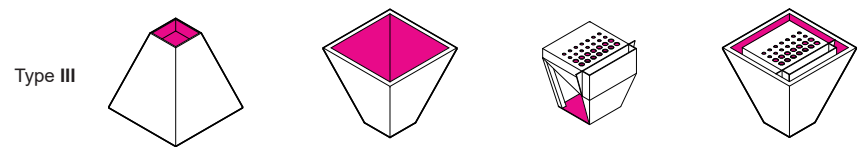
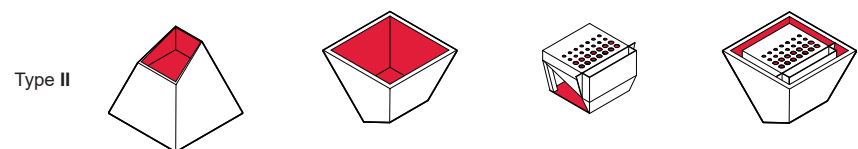
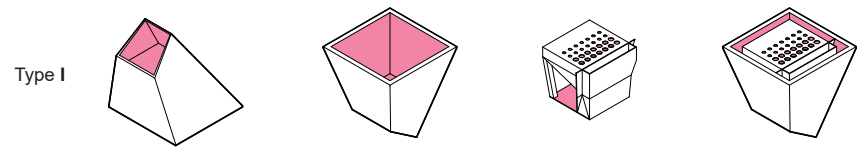

VARIABLE INSERT

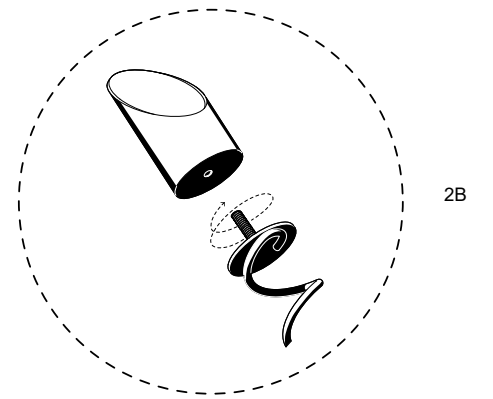
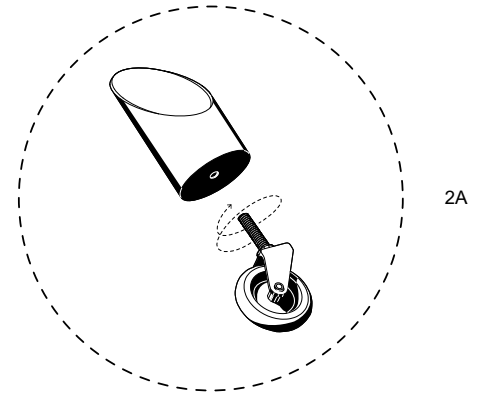
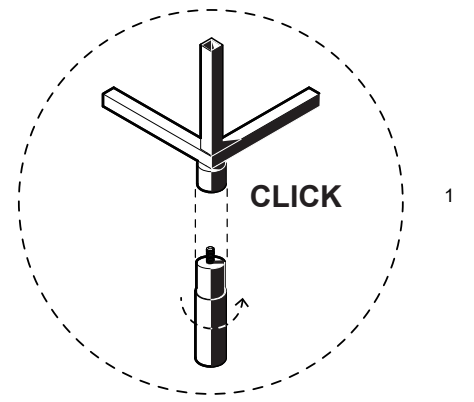
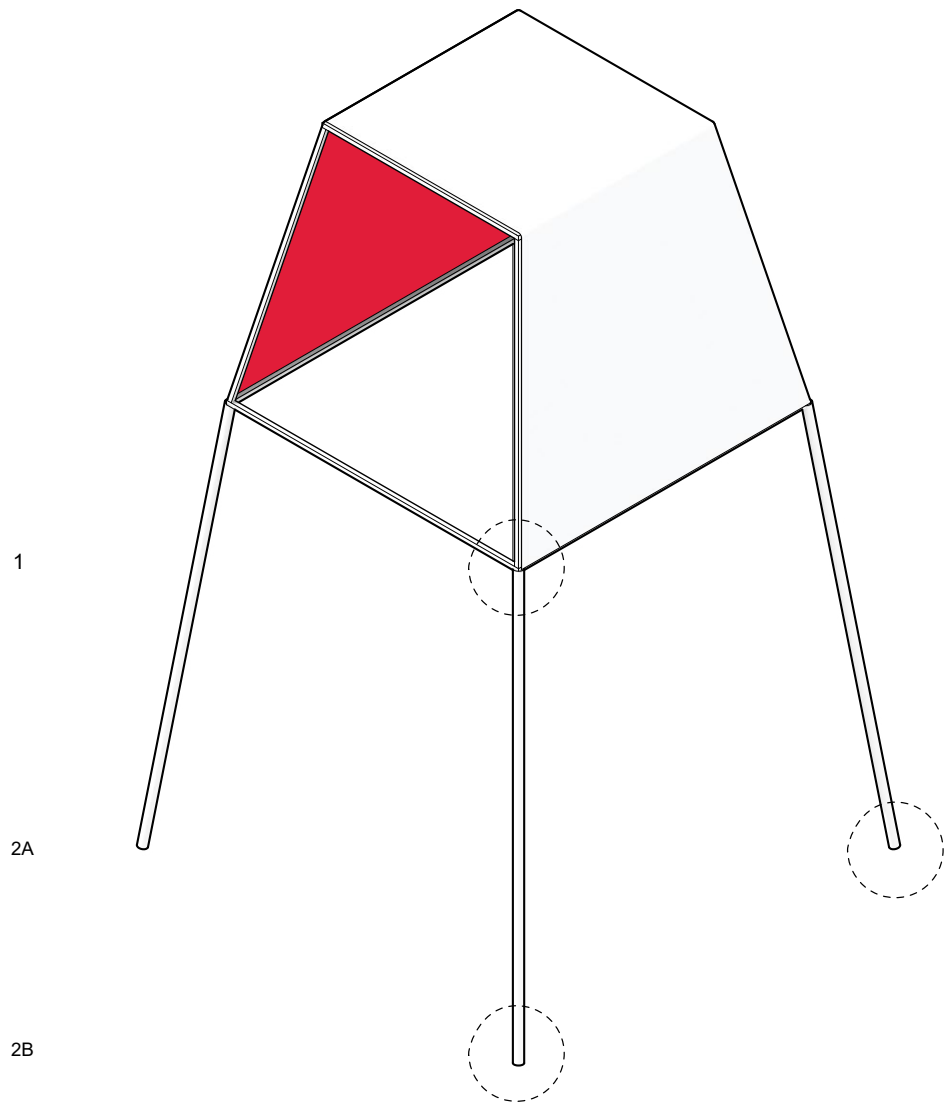

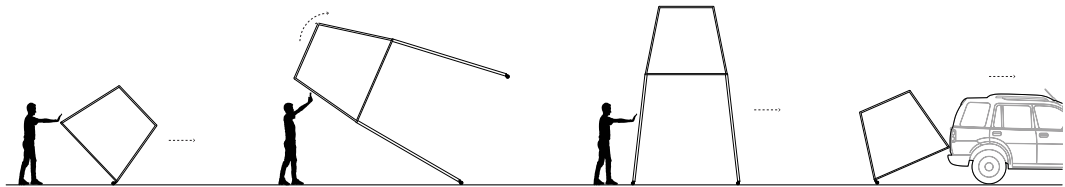
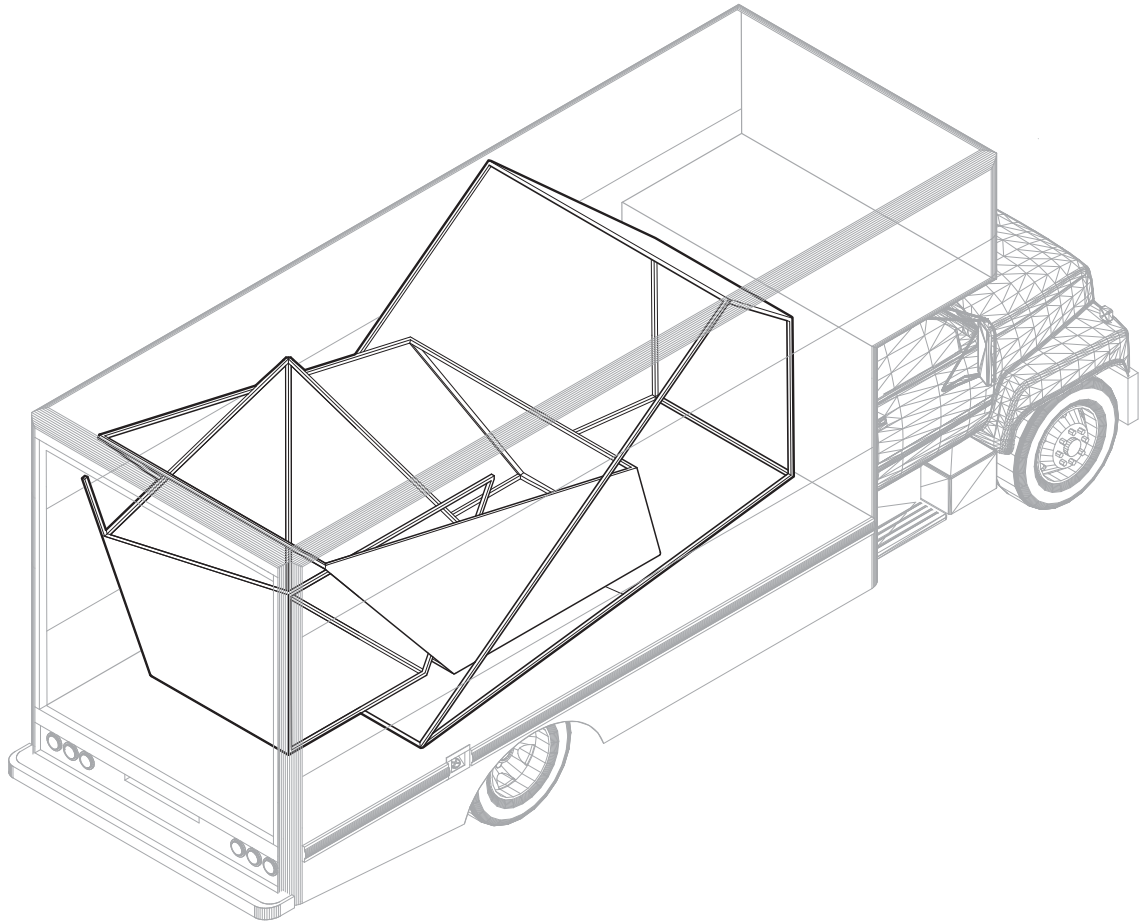
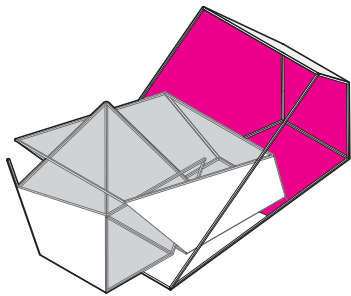
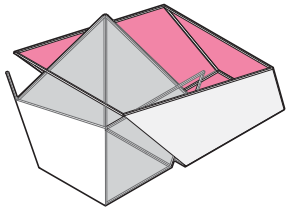
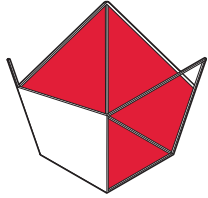





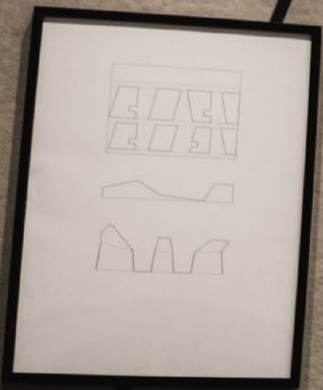





MFA ■ *Glassell School of Art*
Susan and Fayed S. Sarofim Campus



